



200W 4 MODULE MODULAR HIBAY SERIES

BMP-HBV-200-150V-10

- White
- Grey
- Black



SPECIFICATIONS

System Power	200w
Milliamps	1000Ma
LED type	LUMILEDS 5050 28Pcs each Module
Lamp Body Material	Powdercoated Galvanised Steel
Colour Temperature	5700k(3000k,4000kopt)
Luminous Flux	32,000lumens
Luminous Efficacy	160lm/w
CRI	Ra70 (Ra80/90 optional)
Beam Angle	90x90,90x40,60X60, 40x40
Rated Lifespan	>100,000 hours Modules
IP Rating	IP67 Housing , IP68 Modules
Impact rating	IK09
Driver Type	Moso Flicker Free X6-200M286
Operating Temperature	-40°C ~ 50°C
Dimmable	PWM Dimming
Test Reports	ISMT,LCP, TM21, LM80, L70
Lamp Dimension	590x330x180 mm
Net Weight	8.3kg
Warranty	5 years driver, 10 years Modules
Certification	JAS/ANZ TUV

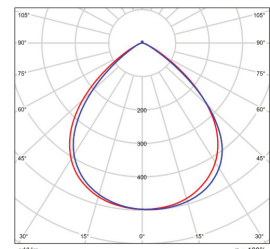
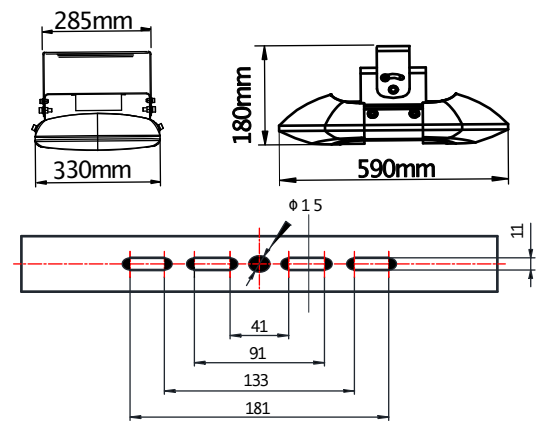

90x90 B/Angle
BMP-HB90-200-150V-10

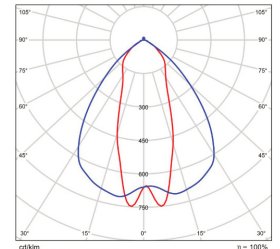

90x40 B/Angle
BMP-HB2211-200-150V-10

Pallet racking isles

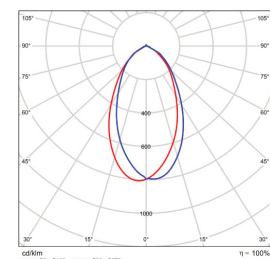

60x60 B/Angle
BMP-HB60-200-150V-10

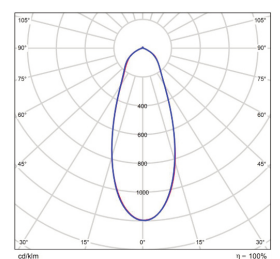

40x40 B/Angle
BMP-HB40-200-150V-10

See modular Photometric for additional beam Angles



200W 4 MODULE MODULAR HIBAY SERIES

BMP-HBV-200-150V-10

For accessories, contact BMP LED via
www.bmpled.com.au/contact

ACCESSORIES



Driver Extension Cable
2.0m,5.0m,12.0 lengths
BMP-DEC/2/5/12-10

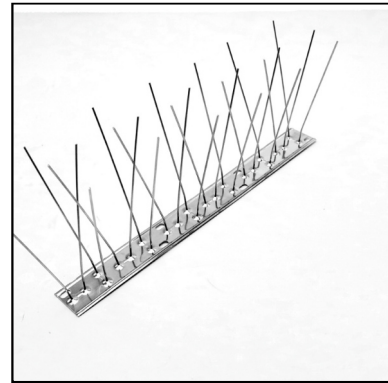

Birdspikes
0.33m
BMP-BIRDSPIKES-10

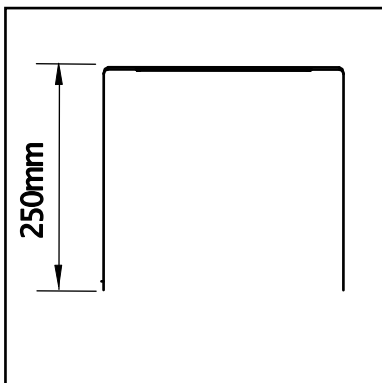

BMP-BRACKET250-10