



# 40W 1 MODULE MODULAR HIBAY SERIES

BMP-HBV-40-150V-10

- White
- Grey
- Black



SPECIFICATIONS	
System Power	40w
Milliamps	800Ma
LED type	LUMILEDS 5050 28Pcs each Module
Lamp Body Material	Powdercoated Galvanised Steel
Colour Temperature	5700k(3000k,4000kopt)
Luminous Flux	6,600lumens
Luminous Efficacy	165lm/w
CRI	Ra70 (Ra80/90 optional)
Beam Angle	90x90,90x40,120X120,
Rated Lifespan	>100,000 hours Modules
IP Rating	IP67 Housing , IP68 Modules
Impact rating	IK09
Driver Type	Moso Flicker Free X6-075M062
Operating Temperature	-40°C ~ 50°C
Dimmable	PWM Dimming
Test Reports	ISMT,LCP, TM21, LM80, L70
Lamp Dimension	360 x 200 x 95 mm
Net Weight	4.8kg
Warranty	5 years driver, 10 years Modules
Certification	JAS/ANZ TUV

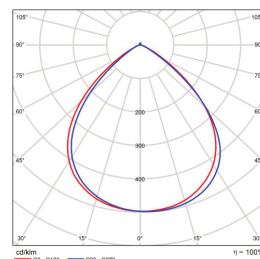
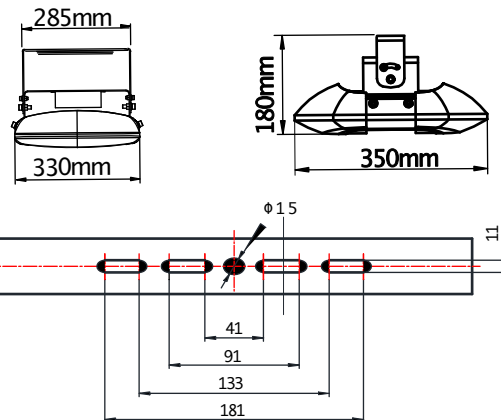

90x90 B/Angle  
BMP-HB90-40-150V-10

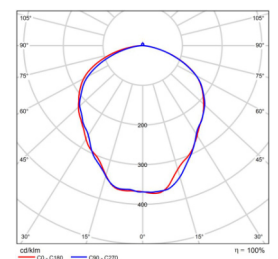

120x120 B/Angle  
BMP-HB120-40-150V-10

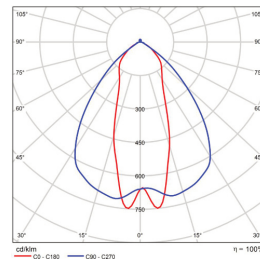

90x40 B/Angle  
BMP-HB2211-40-150V-10  
Pallet racking isles

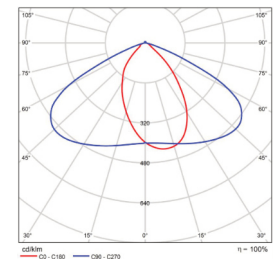

150x50 B/Angle  
BMP-HB2123-40-150V-10

See modular Photometric for additional beam Angles



# 40W 1 MODULE MODULAR HIBAY SERIES

BMP-HBV-40-150V-10

For accessories, contact BMP LED via  
[www.bmpled.com.au/contact](http://www.bmpled.com.au/contact)

## ACCESSORIES



Driver Extension Cable  
2.0m,5.0m,12.0 lengths  
BMP-DEC/2/5/12-10

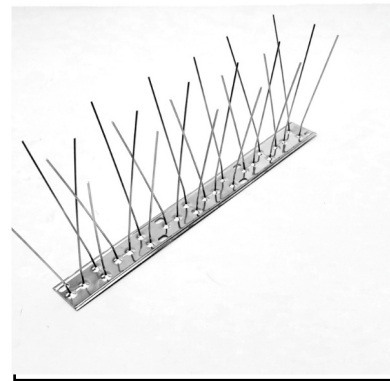

Birdspikes  
0.33m  
BMP-BIRDSPIKES-10

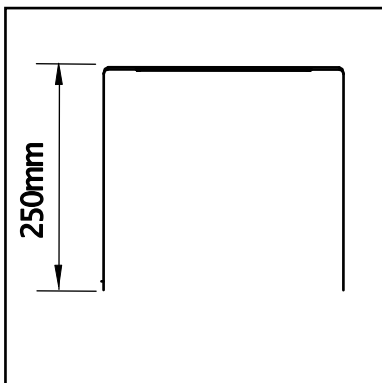

BMP-BRACKET250-10