



**LED**

# 120W 2 MODULE 24VDC STREETLIGHT LIGHT SERIES

BMP-STREET24VDC-120-150V-10

- White
- Grey
- Black



## SPECIFICATIONS

System Power	120w
Milliamps	1200Ma
LED type	LUMILEDS 5050 28Pcs each Module
Lamp Body Material	Aluminium Alloy
Colour Temperature	5700k,4000k,3000k
Luminous Flux	21,410lumens
Luminous Efficacy	178lm/w
CRI	Ra70
Beam Angle	TYPE I, II , III , IV , V
Light Distribution Curve	Various
Rated Lifespan	>100,000 hours Modules
IP Rating	IP66 Housing , IP68 Modules
Impact rating	IK08
Driver Type	Flicker Free D5-100C-56-A
Operating Temperature	-40°C ~ 50°C
Dimmable	PWM Dimming
Test Reports	TM21,LM80,L70
Lamp Dimension	625x330x155 mm
Net Weight	8.4kg
Warranty	5 years driver, 10 years Modules
Certification	JAS/ANZ TUV

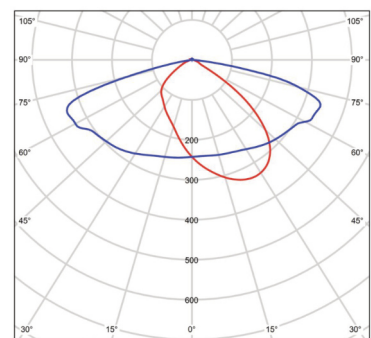
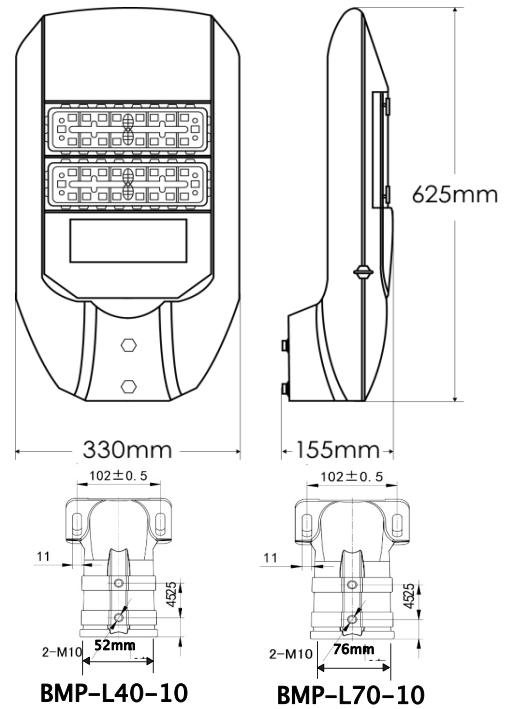

Type II (Most Common)  
BMP-STREET24VDC2-120-150V-10

**See next page for other distributions**



# 120W 2 MODULE 24VDC STREETLIGHT LIGHT SERIES

BMP-STREET24VDC-120-150V-10

For accessories, contact BMP LED via [www.bmpled.com.au/contact](http://www.bmpled.com.au/contact)

## ACCESSORIES

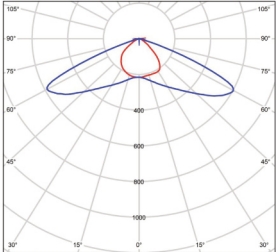

Type I

BMP-STREET24VDC1-120-150V-10

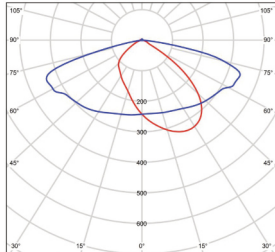

Type II

BMP-STREETV24DC2-120-150V-10

(Most Common)

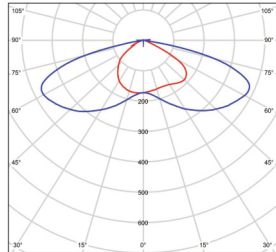

Type III

BMP-STREET24VDC3-120-150V-10

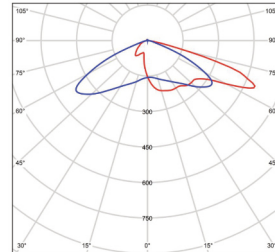

Type IV

BMP-STREET24VDC4-120-150V-10

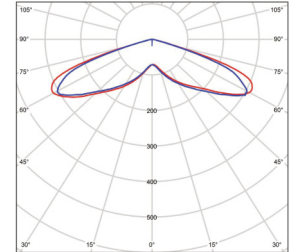

Type V

BMP-STREE24VDC5-120-150V-10

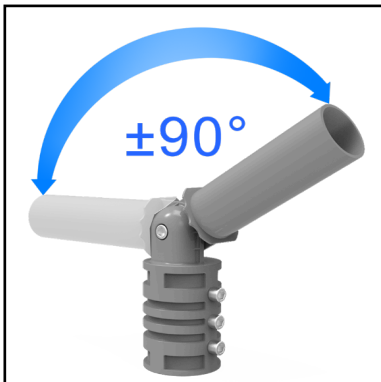

Streetlight pole Adaptor  
Black/Grey/White Options  
BMP-STREETAD-10(B/G/W)



3 Pin Phot Cell  
Pe Cell and base  
BMP-STREETCELL3-10



Driver Extension Cable  
2.0m,5.0m,12.0 lengths  
BMP-DEC/2/5/12-10

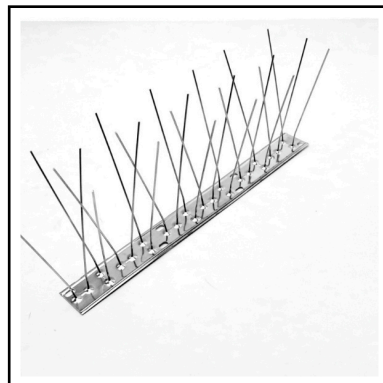

Birdspikes  
0.33m  
BMP-BIRDSPIKES-10