

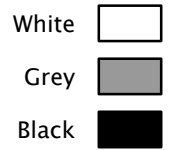

100W 2 MODULE STREETLIGHT LIGHT SERIES

BMP-STREETM-100-15057-10



SPECIFICATIONS

| | |
|--------------------------|----------------------------------|
| System Power | 100w |
| Milliamps | 1000Ma |
| LED type | LUMILEDS 5050 28Pcs each Module |
| Lamp Body Material | Aluminium Alloy |
| Colour Temperature | 5700k,4000k,3000k |
| Luminous Flux | 17,850lumens |
| Luminous Efficacy | 178lm/w |
| CRI | Ra70(Ra80/90 Optional) |
| Beam Angle | TYPE I, II , III , IV , V |
| Light Distribution Curve | Various |
| Rated Lifespan | >100,000 hours Modules |
| IP Rating | IP66 Housing , IP68 Modules |
| Impact rating | IK08 |
| Driver Type | Moso Flicker Free X6-105M150 |
| Operating Temperature | -40°C ~ 50°C |
| Dimmable | PWM Dimming |
| Test Reports | TM21,LM80,L70 |
| Lamp Dimension | 625 x 330 x 155 mm |
| Net Weight | 8.4kg |
| Warranty | 5 years driver, 10 years Modules |
| Certification | JAS/ANZ TUV |

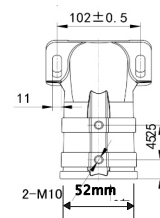
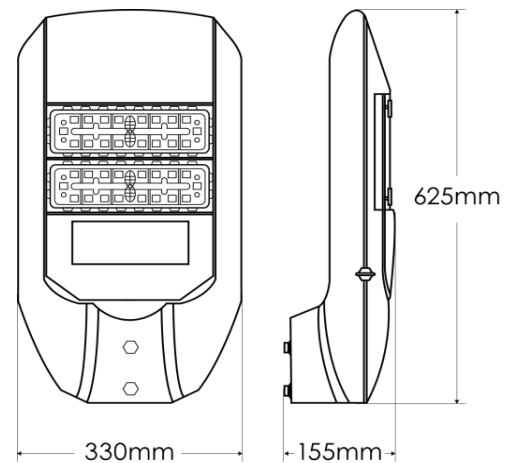

BMP-L40-10

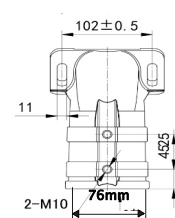

BMP-L70-10

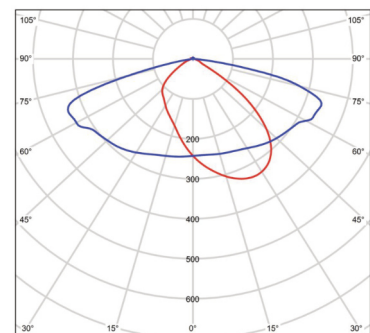

Type II (Most Common)
BMP-STREET2-100-150V-10

See next page for other distributions



100W 2 MODULE STREETLIGHT LIGHT SERIES

BMP-STREETM-100-150V-10

For accessories, contact BMP LED via www.bmpled.com.au/contact

ACCESSORIES

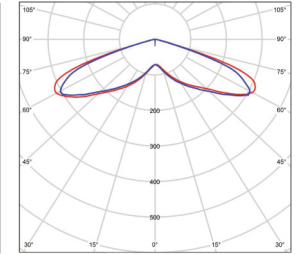
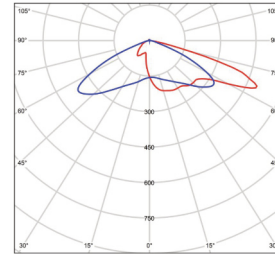
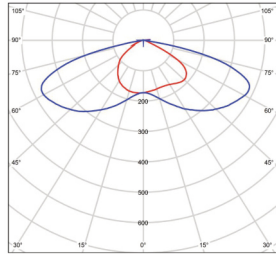
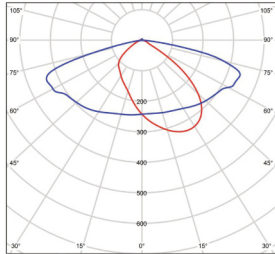
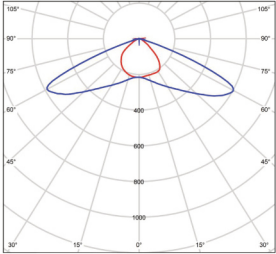

Type I

BMP-STREET1-100-150V-10

Type II

BMP-STREET2-100-150V-10
(Most Common)

Type III

BMP-STREET3-100-150V-10

Type IV

BMP-STREET4-100-150V-10

Type V

BMP-STREET5-100-150V-10

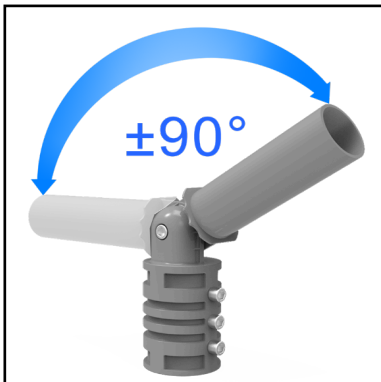

Streetlight pole Adaptor
Black/Grey/White Options
BMP-STREETAD-10(B/G/W)



3 Pin Phot Cell
Pe Cell and base
BMP-STREETCELL3-10



Driver Extension Cable
2.0m,5.0m,12.0 lengths
BMP-DEC/2/5/12-10

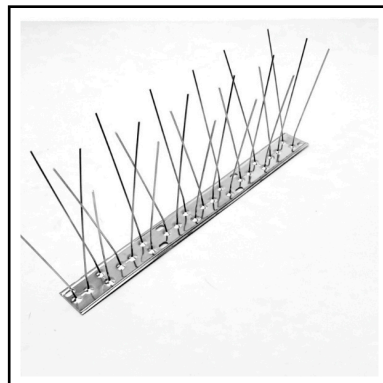

Birdspikes
0.33m
BMP-BIRDSPIKES-10