



50W 1 MODULE STREETLIGHT LIGHT SERIES

BMP-STREETM-50-150V-10

- White
- Grey
- Black



SPECIFICATIONS

System Power	50w
Milliamps	1000Ma
LED type	LUMILEDS 5050 28Pcs each Module
Lamp Body Material	Aluminium Alloy
Colour Temperature	5700k,4000k,3000k
Luminous Flux	8,950lumens
Luminous Efficacy	178lm/w
CRI	Ra70(Ra80/90 Optional)
Beam Angle	TYPE I, II , III , IV , V
Light Distribution Curve	Various
Rated Lifespan	>100,000 hours Modules
IP Rating	IP66 Housing , IP68 Modules
Impact rating	IK08
Driver Type	Moso Flicker Free X6-075M062
Operating Temperature	-40°C ~ 50°C
Dimmable	PWM Dimming
Test Reports	TM21,LM80,L70
Lamp Dimension	577 x 330 x 155 mm
Net Weight	7.2kg
Warranty	5 years driver, 10 years Modules
Certification	JAS/ANZ TUV

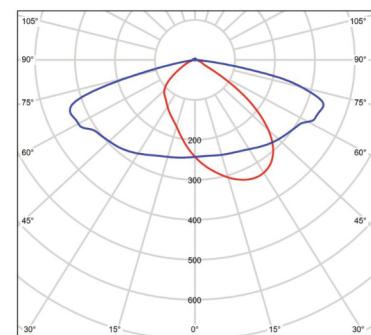
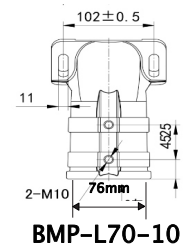
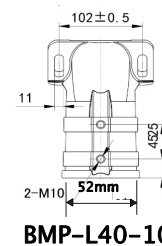
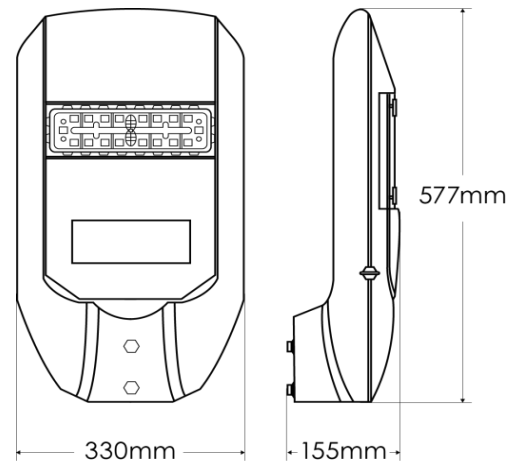

Type II (Most Common)
BMP-STREET2-50-150V-10

See next page for other distributions



50W 2 MODULE STREETLIGHT LIGHT SERIES

BMP-STREETM-50-150V-10

For accessories, contact BMP LED via www.bmpled.com.au/contact

ACCESSORIES

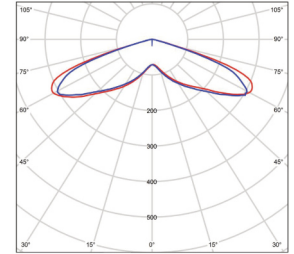
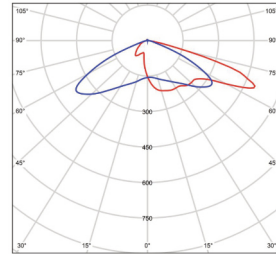
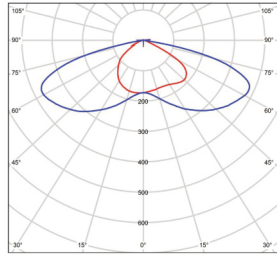
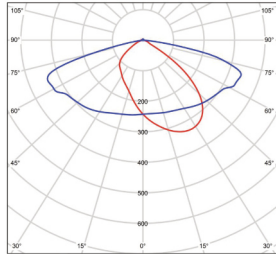
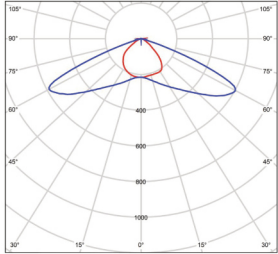

Type I
BMP-STREET1-50-150V-10

Type II
BMP-STREET2-50-150V-10
(Most Common)

Type III
BMP-STREET3-50-150V-10

Type IV
BMP-STREET4-50-150V-10

Type V
BMP-STREET5-50-150V-10

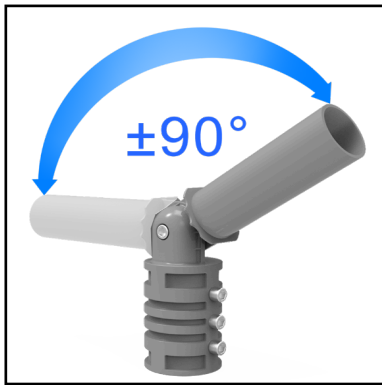

Streetlight pole Adaptor
Black/Grey/White Options
BMP-STREETAD-10(B/G/W)



3 Pin Phot Cell
Pe Cell and base
BMP-STREETCELL3-10



Driver Extension Cable
2.0m,5.0m,12.0 lengths
BMP-DEC/2/5/12-10

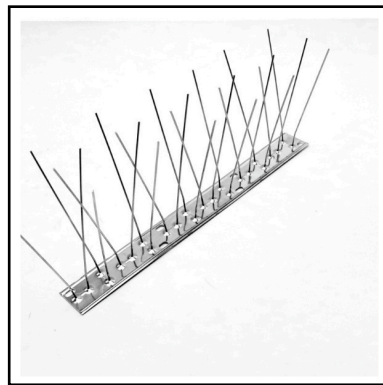

Birdspikes
0.33m
BMP-BIRDSPIKES-10