



40W 1 MODULE MODULAR FLOODLIGHT SERIES

BMP-FLMODV-40-150V-10

- White
- Grey
- Black



SPECIFICATIONS

System Power	40w
Milliamps	800Ma
LED type	LUMILEDS 5050 28Pcs each Module
Lamp Body Material	Powdercoated Galvanised Steel
Colour Temperature	5700k(3000k,4000kopt)
Luminous Flux	6,810lumens
Luminous Efficacy	169lm/w
CRI	Ra70 (Ra80/90 optional)
Beam Angle	90x90,90x40,25x25, 150x90, 160x40Vertical
Rated Lifespan	>100,000 hours Modules
IP Rating	IP67 Housing , IP68 Modules
Impact rating	IK09
Driver Type	Moso Flicker Free X6-075m062
Operating Temperature	-40°C ~ 50°C
Dimmable	PWM Dimming
Test Reports	ISMT,LCP, TM21, LM80, L70
Lamp Dimension	360 x 200 x 95 mm
Net Weight	3.2kg
Warranty	5 years driver, 10 years Modules
Certification	JAS/ANZ TUV

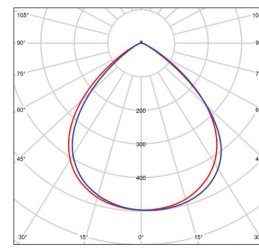
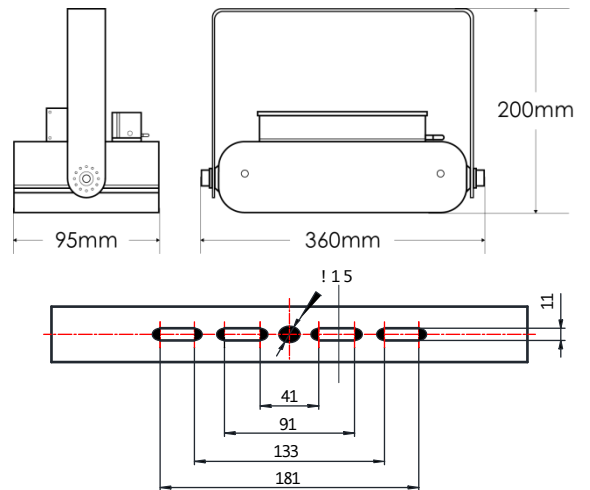

90x90 B/Angle
BMP-FLMOD90-40-15057-10

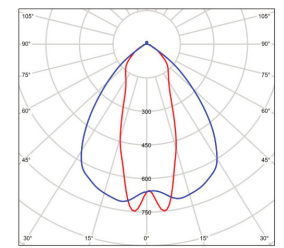

90x40 B/Angle
BMP-FLMOD2211-40-15057-10

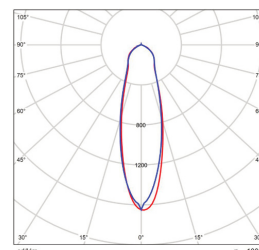

25x25 B/Angle
BMP-FLMOD25-40-15057-10

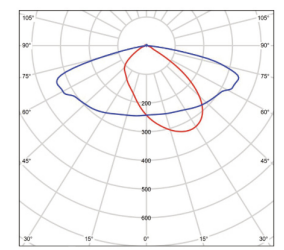

150x90 B/Angle
BMP-FLMOD7530-40-15057-10

See modular Photometric for additional beam Angles



40W 1 MODULE MODULAR FLOODLIGHT SERIES

BMP-FLMODV-40-150V-10

For accessories, contact BMP LED via
www.bmp-led.com.au/contact

ACCESSORIES



Driver Extension Cable
2.0m, 5.0m, 12.0 lengths
BMP-DEC/2/5/12-10

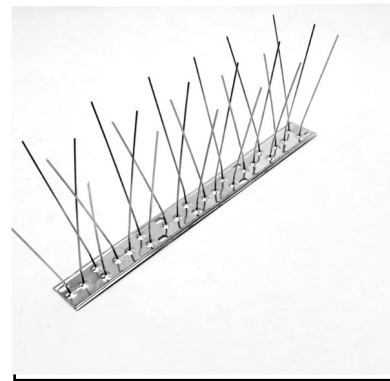

Birdspikes
0.33m
BMP-BIRDSPIKES-10



Red Laser pointer
BMP-REDLPOINT-10

